



连云港美华电子科技有限公司
Lianyungang Meihua Electronics Technology Co.,Ltd

产品规格书

DATA SHEET

Part No: MHL3014UYTD
REV.2

本产品符合 ROHS 指令有关限制有害物质的环保要求.

日期 DATE	拟制 PREPARED	审核 VERIFIED	批准 APPROVED
2018-05-19	Liu		John
客户签回 CUSTOMER'S APPROVAL			

电 话 Tel: 0518-83286000

传 真 Fax: 0518-83696699

邮件 E-mail: sales@lygmh.com.cn

网 址 Web: <http://www.lygmh.com.cn>

地址 ADD: 中国·江苏省连云港市灌南经济开发区北环路

North Around Road,Guannan EDA,Lianyungang City,Jiangsu Province China.



连云港美华电子科技有限公司

P/N:MHL3014UYTD

LED LAMP

产品外观尺寸 PACKAGE DIMENSIONS

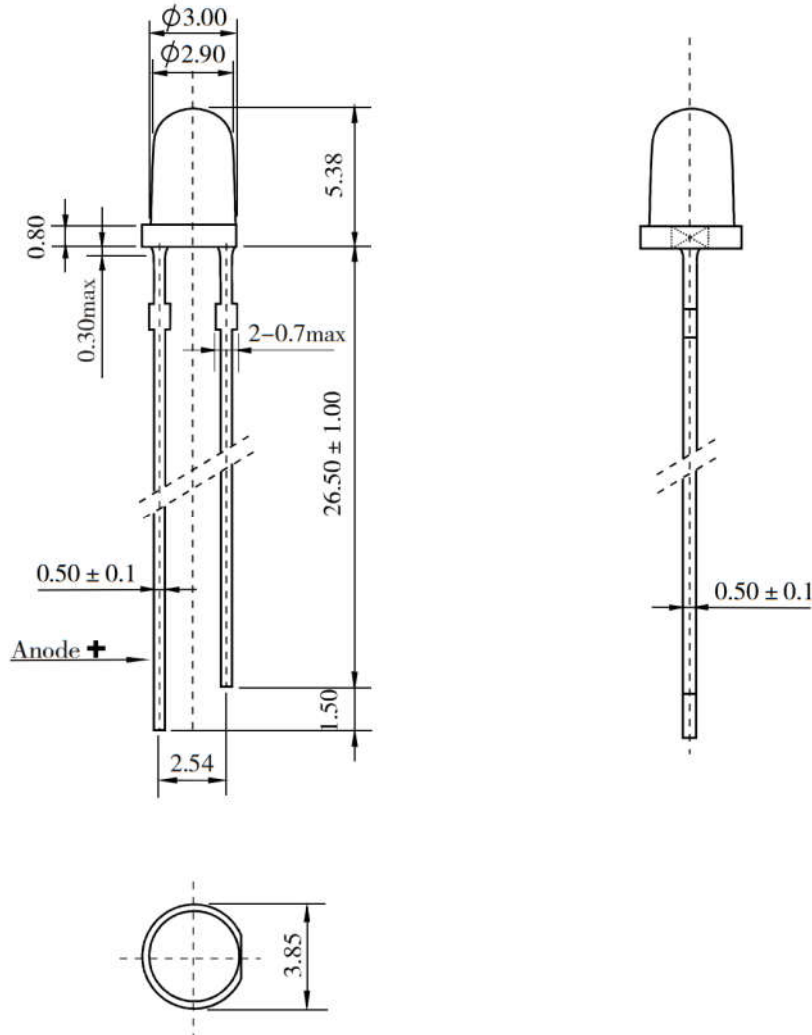

注意 NOTES :

1. 所有尺寸均为 mm(英寸)

All dimensions are in millimeters. (inches)

2. 如无特殊说明, 公差为 0.25 mm(0.010 ")

Tolerance is ± 0.25 mm(0.010 ") unless otherwise specified.

3. 溢胶最大 1.5 mm

Protruded resin under flange is 1.5 mm(0.059 ") max.

4. 此 LED 防静电(人体模型) <-2000 V

Highlight <-2000 V the led can withstand the max static level when assembling or operation (HBM)



连云港美华电子科技有限公司

P/N:MHL3014UYTD

LED LAMP

产品特性 FEATURES

- 高可靠性和高稳定性
High intensity and reliability
- 高品质、和低功耗、低成本
High quality, Low power requirement and low cost
- IC 易兼容、易装配
IC compatible, Easy assembly
- 符合 RoHS 指令要求
ROHS COMPLIANT
- 无铅产品
Pb FREE PRODUCTS
- 静电承受能力 2000V(HBM)
ESD 2000V(HBM).

产品特征 Description

- 3mm 直径封装
3mm diameter package
- 为高亮度应用而设计的产品
The series specially designed for applications requiring higher brightness.
- 优秀的室内环境性能
Superior performance in indoor environment.
- 发光颜色 Emitted color:
 1. 黄色: Ultra Yellow
 - 2.
 - 3.
- 晶片材质 Chips materials:
 1. AlGaAs/GaAs
 - 2.
 - 3.
- 胶体类型 Lens Type
黄色雾状 Yellow Diffused



连云港美华电子科技有限公司

P/N:MHL3014UYTD

LED LAMP

极限参数 Absolute Maximum Ratings(Ta=25℃)

参数 Parameter	符号 Symbol	极限值 Rating	单位 Unit
单字节功耗 Power Dissipation Per Segment	PAD	80	mw
最大峰值电流 Peak Forward Current Per Segment (1/10 duty cycle, 0.1ms pulse width)	IPF	100	mA
最大使用电流 Continuous Forward Current Per segment	IAF	30	mA
反向电压 Reverse Voltage	VR	5	V
工作温度 Operating Temperature Range	TOPR	-25℃ to 85℃	
储藏温度 Storage Temperature Range	TSTG	-30℃ to 100℃	

光电特性 Optical-Electrical Characteristic(Ta=25℃)

符号 Symbol	参数 Parameter	测试条件 Test Condition	最小 Min	标准 Typ	最大 Max	单位 Unit
V _F	正向压降 Forward Voltage	IF = 20mA	-	2.0	2.4	V
I _R	反向漏电流 Reverse Current	VR=5V	-	-	50	uA
λ _D	主波长 Dominant Wavelength	IF = 20mA	-	590	-	nm
λ _P	峰值波长 Peak Wavelength	IF = 20mA	-	593	-	nm
Δλ	半波宽 Spectral Line Half-Width	IF = 20mA	-	20	-	nm
2θ _{1/2}	半视角 Half Intensity Angle	IF=20mA	-	40	-	deg
I _v	发光强度 Luminous Intensity	IF = 10mA	145	280	-	mcd



光电特性图 Typical Electrical Characteristic Curves(Ta=25°C)

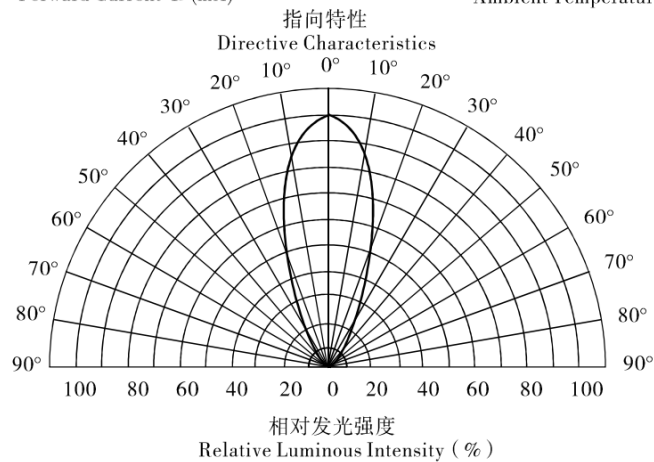
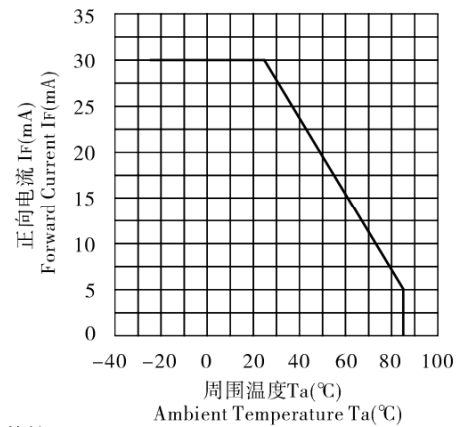
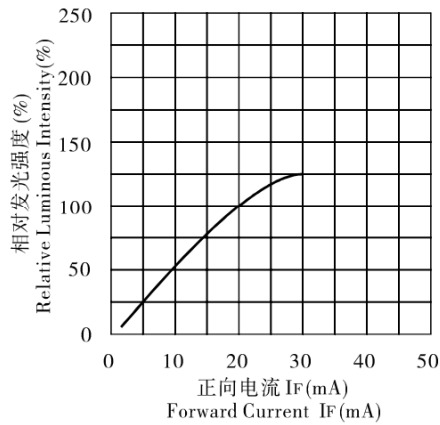
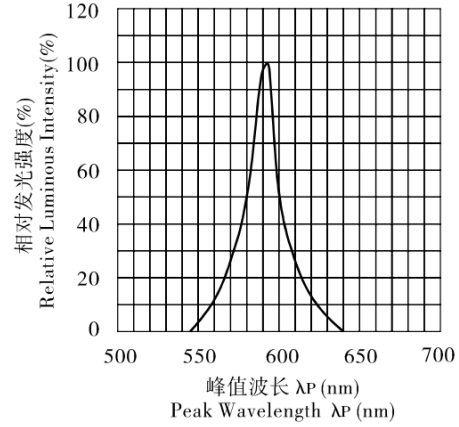
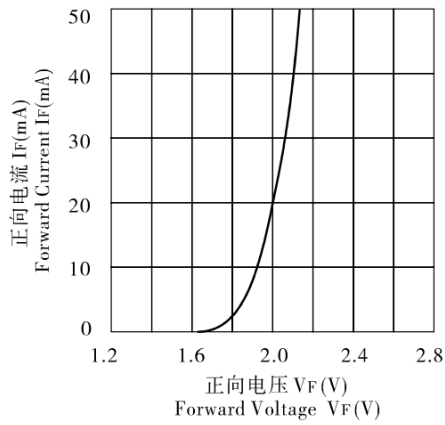

Note:

1. 发光强度取平均值 Luminous Intensity is a average value
2. 发光强度公差: ±10% Tolerance of Luminous Intensity: ±10%
3. 正向电压公差: ± 0.1V Tolerance of Forward Voltage: ± 0.1V



连云港美华电子科技有限公司

P/N:MHL3014UYTD

LED LAMP

标签 Label1

连云港美华电子科技有限公司

P/N:MHL3014UYTD

L/N: xxxxxxxxxxxx

QTY:xxxx pcs

DATA: xxxxx

- P/N:型号 Part Number
- LOT No: 生产单号 Lot Number
- QTY: 数量 Packing Quantity
- DATA :生产日期 Data Code
- IV:亮度 Luminous Intensity(参考 Reference)
- VF:电压 Forward Voltage(参考 Reference)



焊接 SOLDERING

方法 METHOD	焊接条件 SOLDERING CONDITIONS	备注 REMARK
浸焊 DIP SOLDERING	沐浴温度: 260°C 最高 Bath temperature: 260°C max 浸润时间: 5 sec 内 Immersion time: within 5 sec	焊接点不要在距封装 2mm 以内 Solder no closer than 2mm from the base of the package 建议使用树脂助焊剂 Using soldering flux, "RESIN FLUX" is recommended.
烙铁焊 SOLDERING IRON	烙铁功率要小于 30W Soldering iron: 30W or smaller 烙铁头温度小于: 350°C Temperature at tip of iron: 350°C or lower 焊接时间: 5 sec 内 Soldering time: within 5 sec.	焊接时烙铁头请勿碰到 PIN During soldering, take care not to press the tip of iron against the PIN (阻止热量直接传到 PIN 上.) (To prevent heat from being transferred directly to the PIN.)

浸焊温度曲线 DIP SOLDERING profile

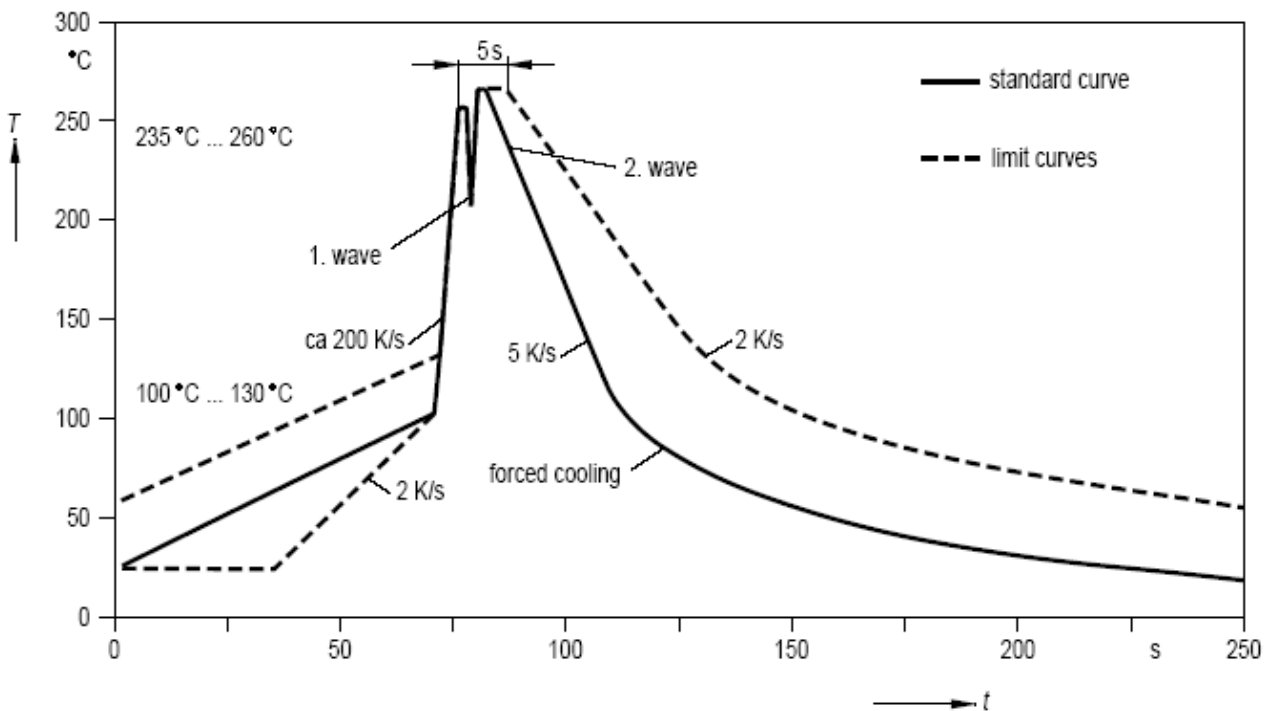



连云港美华电子科技有限公司

P/N:MHL3014UYTD

LED LAMP

储藏 STORAGE

1. LED 在出厂后可在温度 30 度以下, 湿度 70% 以下的环境内保存 3 个月时间 The LED should be stored at 30°C or less and 70% RH or less after being shipped from MH and the storage life limits are 3 months.

2. 美华的 LED 是铁合金镀锡的, 表面的镀层会被腐蚀性气体侵蚀, 因此不要将它保存在可能导致支架氧化, 失去光泽或变色的环境, 这些腐蚀可能会导致焊接困难, 建议尽快使用 Meihua's LED lead frames are comprised of a stannum plated iron alloy. The silver surface may be affected by environments which contain corrosive gases and so on. Please avoid conditions which may cause the LED to corrode, tarnish or discolor. This corrosion or discoloration may cause difficulty during soldering operations. It is recommended that the LED be used as soon as possible.

3. 请避免保存在温度变化明显, 尤其是高湿度的地方 Please avoid rapid transitions in ambient temperature, especially, in high humidity environments where condensation can occur.

使用注意事项 Application Restrictions

1. 本文档中所描述的规范。上述规格可变更不通知。美华将对上述规格的材料更改的保留权。specification described in this document. Above specification may be changed without notice. Meihua will reserve authority on material change for above specification.

2. 使用本产品时, 请遵守绝对最大额定值及这些规格书的使用说明。美华不负责的使用造成的任何损害承担产品不符合绝对最大额定值, 并在这些指令中包含规格书。When using this product, please observe the absolute maximum ratings and the instructions for using outlined in these specification sheets. Meihua assumes no responsibility for any damage resulting from use of the product which does not comply with the absolute maximum ratings and the instructions included in these specification sheets.

3. 这些规格表包括美华公司下版权保护的材料。请不要复制或导致任何人没有提供同意复制。These specification sheets include materials protected under copyright of Meihua Corporation. Please don't reproduce or cause anyone to reproduce them without Meihua's consent.



连云港美华电子科技有限公司

P/N:MHL3014UYTD

LED LAMP

4. 静电放电（静电放电）ESD (Electrostatic Discharge)

产品敏感的静电或冲击电压。当使用产品时静电放电会损坏模具及其可靠性。对静电放电的措施强烈推荐: **The products are sensitive to static electricity or surge voltage. ESD can damage a die and its reliability. When handling the products, the following measures against electrostatic discharge are strongly recommended:**

消除电荷 **Eliminating the charge**

接地的手环，防静电鞋，衣服和地板 **Grounded wrist strap, ESD footwear, clothes, and floors**

接地的工作站设备和工具 **Grounded workstation equipment and tools**

导电材料的防静电工作台/架子 **ESD table/shelf mat made of conductive materials**

正确的接地用于所有装置、设备和机器生产过程所必须。在产品设计时应考虑冲击保护。**Proper grounding is required for all devices, equipment, and machinery used in product assembly. Surge protection should be considered when designing of commercial products.**

如果工具或设备含有绝缘如玻璃或塑料材料，需要做下列静电放电预防措施: **If tools or equipment contain insulating materials such as glass or plastic, the following measures against electrostatic discharge are strongly recommended:**

用导电材料耗散静电电荷 **Dissipating static charge with conductive materials**

保持环境的湿度 **Preventing charge generation with moisture**

使用离子风扇中和静电 **Neutralizing the charge with ionizers**

5. 发光二极管正向电流方向使用，驱动电路的设计必须使 LED 在关闭的状态下不经受正向或逆向电压，如果反向电压不断应用于发光二极管，它可以导致 LED 损坏 The LEDs should be operated with forward bias. The driving circuit must be designed so that the LEDs are not subjected to forward or reverse voltage while it is off. If reverse voltage is continuously applied to the LEDs, it may cause migration resulting in LED damage.